



Product range

Order code	Description
zc-ss-3sw-blk	Smart switch with 3 buttons to suit 84 mm wall mount, black
zc-ss-3sw-wht	Smart switch with 3 buttons to suit 84 mm wall mount, white

Features

- 2 mA DALI line current
- Up to 63 units per DALI line
- Black and white finishes available
- Tactile buttons for user accessibility
- Replaceable buttons with customisable printing
- Used on wired and wireless DALI networks
- Selectable button actions on DALI-2 application controller

Dimensions (mm)

Fixing centres	84 mm	Dimensions	W75 / H117 / D34 mm
----------------	-------	------------	---------------------

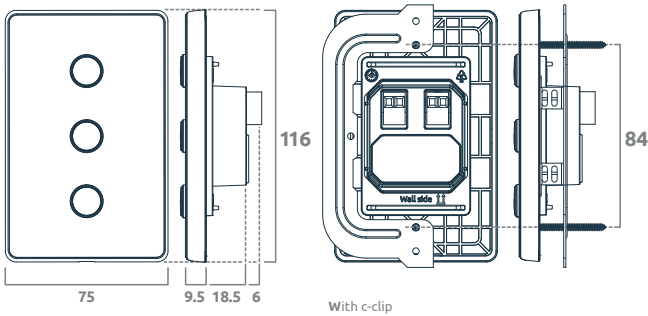

Notice

- The DALI line is not SELV. It must be treated like LV mains and treated with the same precautions and wiring regulations.
- This product is not bus powered and requires the 240V supply to be connected

Specifications

Supply	220 - 240 V~ 50Hz	
Class	II	
Control system	Wired DALI-2	Wireless IEC62386-104 over Thread
Radio support	IEEE 802.15.4	
Frequency band	2.4 GHz	
Max radio tx power	+8 dBm	
DALI line current	2 mA	
Wiring	0.5 - 2.5 mm ²	Strip 7 mm
Operating temperature	0 to 55°C	
Material	PC UV stabilised, toughened glass, aluminium	
Ingress protection	IP20	
Compliance standards	IEC 60669-2-1 CISPR 15 IEC 62386-301	EMC-2004/108/EC LVD-2006/95/EC IEC 62386-104

System overview: modes

104 mode is enabled after the device has been added to a 104 application controller such as zc-iot-fc.



104 + 101 Bridge mode is enabled after the device has been added to a 104 controller and a 101 power supply has been connected to the DALI terminals.

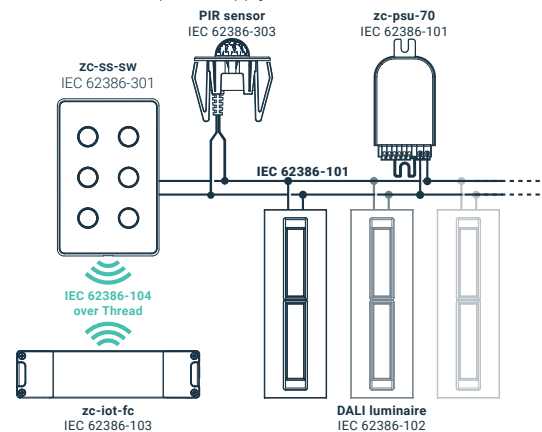

101 mode is enabled after a 101 power supply has been connected to the DALI terminal and the device **has not** been added to a 104 application controller.

